



THE BEST HAS A NAME
ORSI *Group*



44° 41' 13" N
11° 20' 17" E

FOR TRADITION
ONE STEP AHEAD

HYDRAULIC HEDGE MOWERS | AGRICULTURAL SERIES

WWW.ORSIGROUP.IT

COMMAND

CLASSIC

Standard

COMMAND WITH PROGRESSIVE TELEFLEXIBLE CABLES

Maximum reliability and robustness, high easy use.



EASY-TRONIC

MECHANICAL CABLE PROPORTIONAL SINGLE LEVER CONTROL 1st AND 2nd MOVEMENT + 3rd AND 4th ELECTRIC MOVEMENT WITH ON-OFF BUTTONS. EASE OF MOVEMENT AND STRENGTH

The EASY-TRONIC control has the proportional movements of the 1st and 2nd arm operated by the joystick. The electric movement of the head inclination takes place via 2 buttons ("ON / OFF", 3rd movement), the floating function is activated with a dedicated switch ("0 / 1"). 2 other buttons on the joystick control the electric movement of the rotation of the hydraulic column (4th movement if present).

The positioning of all the switches on the back of the joystick allows the operation of all movements with a single hand. The rotor is switched on and off by means of a tele-flexible cable control with lever. The rotor control is equipped with an anti-rotation safety lever for involuntary / accidental inversion of the rotor.



SINGLE MOVEMENTS



NEW SMART-TRONIC V2.1

AVAILABLE STARTING
FROM THE 1/1/2023



SIMULTANEOUS
MOVEMENTS

JOYSTICK WITH 5 ELECTRO-PROPORTIONAL COMPENSATED MOVEMENTS

An ergonomic and highly sensitive joystick where everything is in the palm of one hand. Very small footprint in the cockpit, the joystick puts the operator in complete control via a small electrical cable.

The SMART-TRONIC command has all of the movements proportional and compensated which allow a simultaneous use without having any losses in pressures or functions that slow down or freeze. The 1st and 2nd boom are controlled by the joystick and the rotor activation goes with an electric command and has a timer on the change of the rotor's direction. The float function is also selected by a button on the Joystick whilst the proportional movement of the head inclination is adjusted by a roller on the joystick. Using other two rollers on the joystick you control the proportional movement of the slew and of the telescopic arm (if equipped).

The machine comes with mechanical levers as a standard equipment for emergency operations without having to use the Joystick. Each element of the distributor is equipped with its own integrated proportional valve with a pressure compensator to allow multiple and simultaneous movements.

SMART-TRONIC



OUT OF PRODUCTION FROM
THE 31/12/2022



SIMULTANEOUS
MOVEMENTS

COMPENSATED ELECTRO-PROPORTIONAL COMMAND 5 ELECTROPROPORTIANATE MOVEMENTS (3 COMPENSATED)

High sensitivity, ergonomic command with everything at your fingertips. Very small footprint in the cockpit, the joystick puts the operator in complete control via a small electrical cable.

The SMART-TRONIC command has all proportional movements, 3 of which are compensated thus allowing simultaneous use without having dips in pressures or functions that slow down or freeze the operation. The 1st and 2nd arms are controlled by the joystick and the rotor activation operated by buttons with rotor safety anti-reversal timer. The float function is also selected by a button on the Joystick whilst the proportional movement of the head angle is adjusted by a roller on the joystick. Pressing 2 buttons on the joystick, changes the movement of the joystick to operate proportional movements of the slew (if equipped).

In case of problems, there are mechanical levers for a possible temporary operation without Joystick. Each element of the distributor is equipped with its own integrated proportional valve with pressure compensator to allow multiple movements to be moved simultaneously.

THE ORSI QUALITY

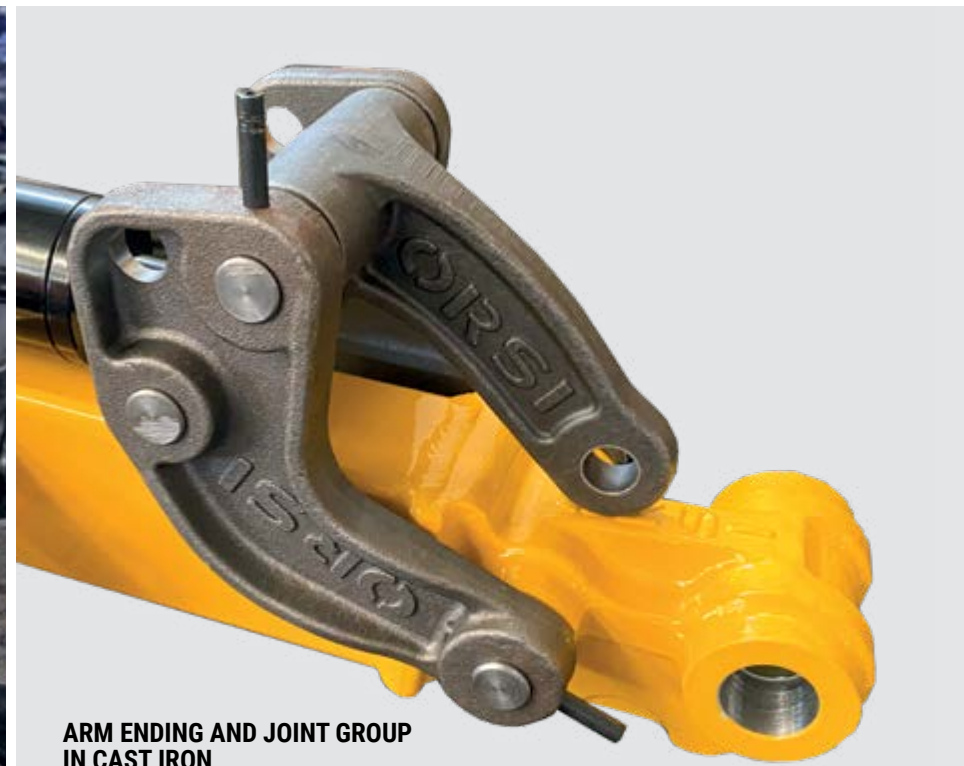

**ARM ENDING AND JOINT GROUP
IN CAST IRON**

HYDRAULIC SYSTEM

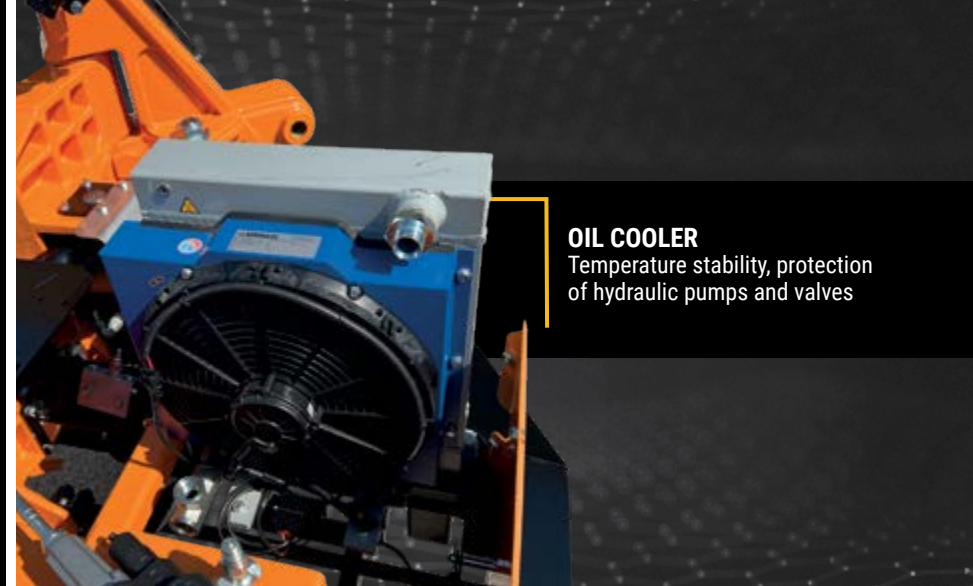

OIL COOLER
Temperature stability, protection of hydraulic pumps and valves



GEAR PUMP AND MOTOR



OVERCENTER VALVES
(only smart-tronic and fast-tronic)

CAST-IRON GEARBOX



FILTERING SYSTEM TO PROTECT HYDRAULIC COMPONENTS

MANUAL EMERGENCY LEVERS

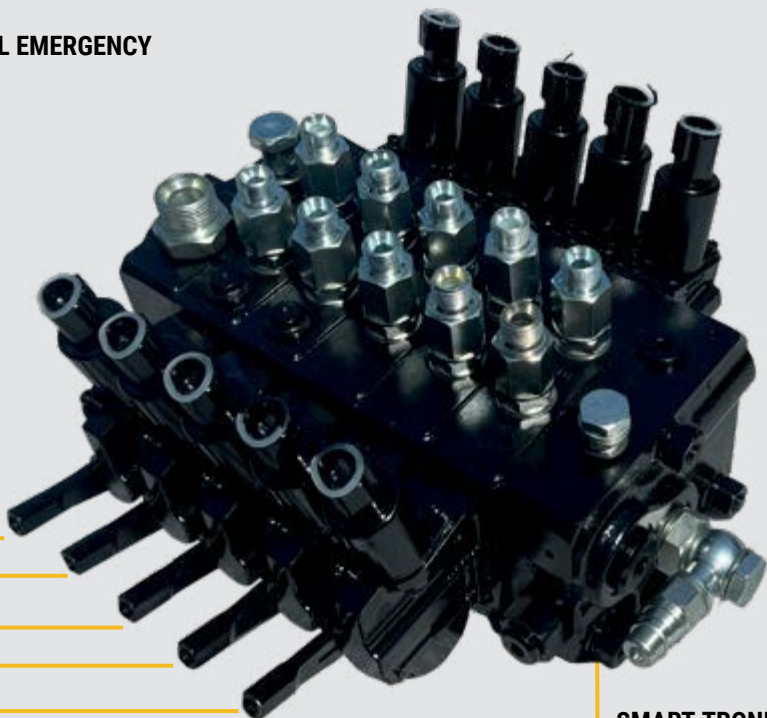

SMART-TRONIC, ELECTRO PROPORTIONAL AND COMPENSATED MONOBLOCK VALVE

TRACTOR ATTACHMENTS

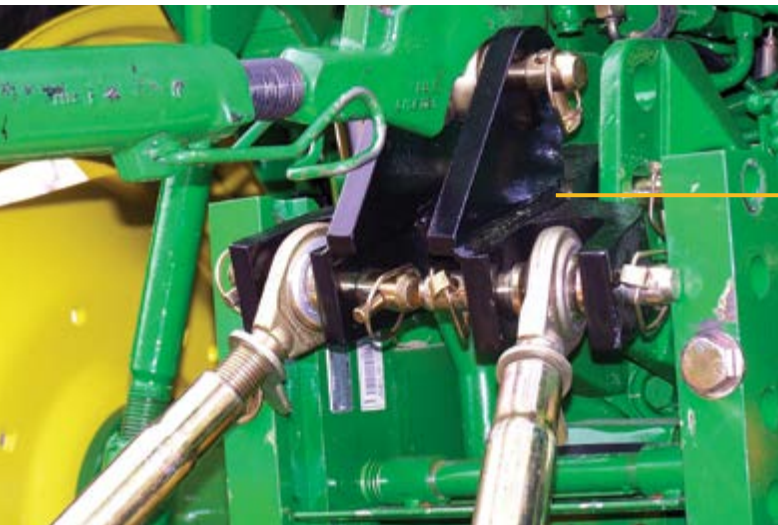
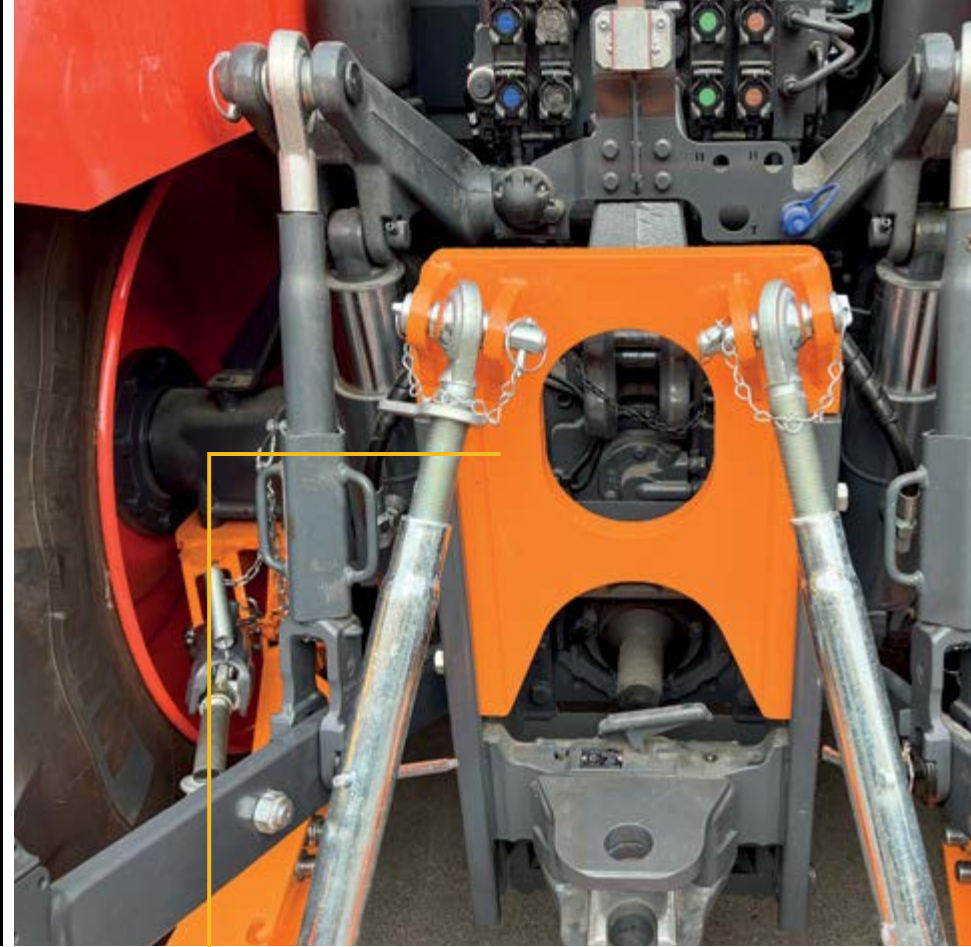

BRACKET (optional)

For use in conjunction with stabilizers
If the tractor is not equipped with suitable anchorage points for stabilizers.

STABILIZERS HITCH PLATE (recommended options)

Some tractors are equipped with a sledge tow hook.
This type of attachment for tensioners makes the mounting of the hedge cutter on the tractor more rigid.

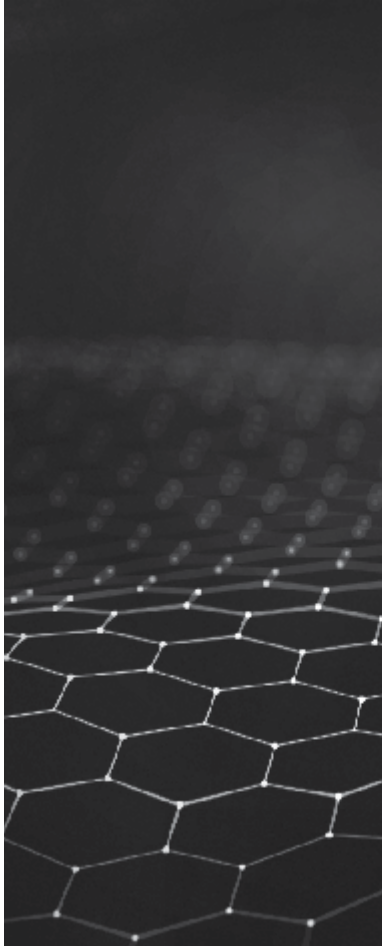

RAPID LINK

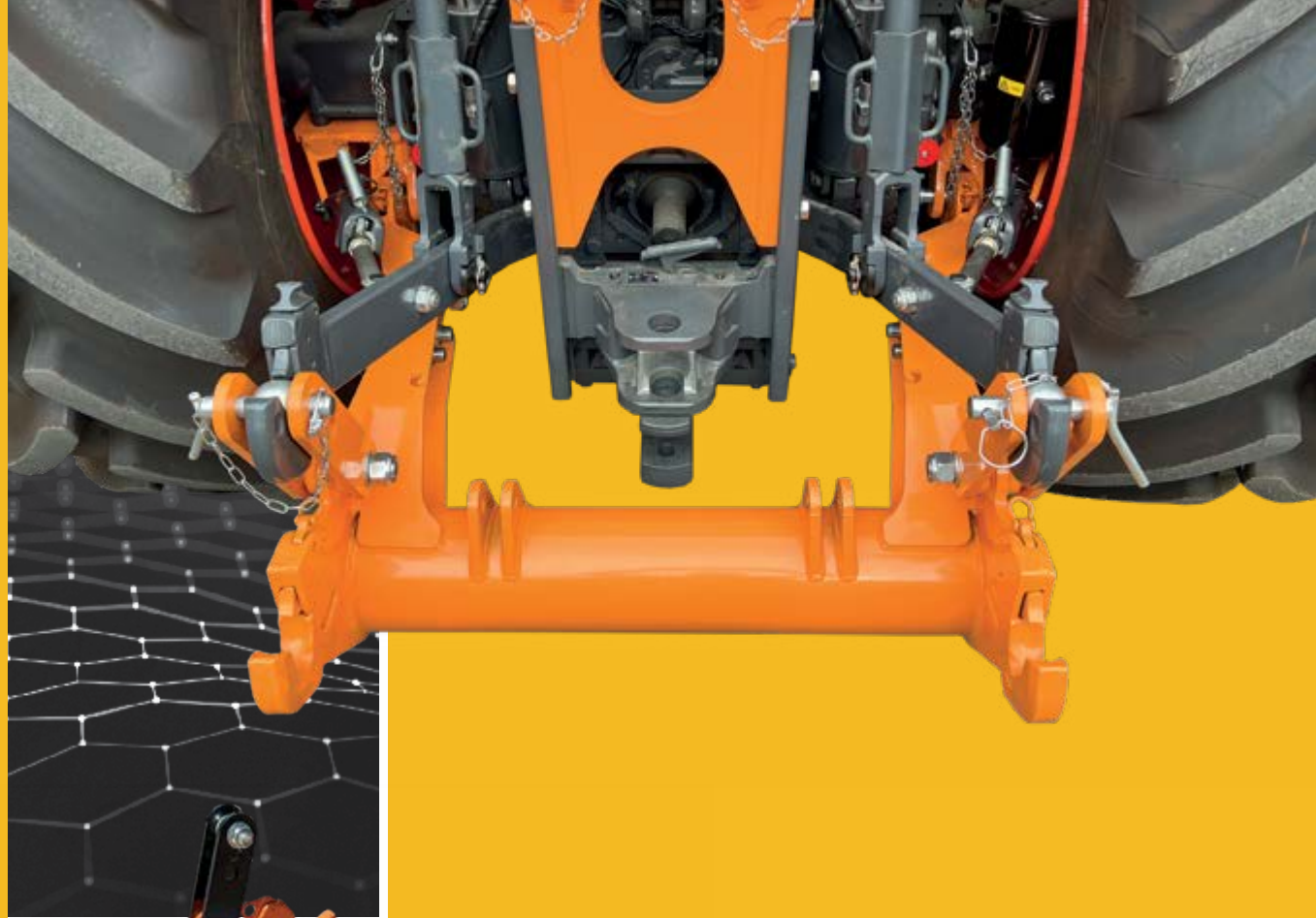

RAPID LINK

(recommended options)

Much stronger and more stable mounting frame than the tractor linkage. Quick assembly and disassembly.



SCAN ME

LEVELING SYSTEMS

***NO FLOATING NO SUSPENSION**

A continuous manual input is required.

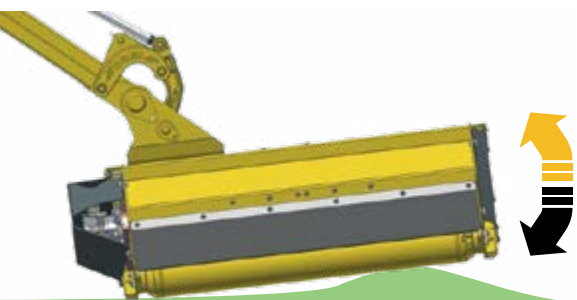

CUTTING HEAD WITH FLOATATION SYSTEM

Allows the cutting head to follow automatically the shape of the ground in a vertical plane, reducing the required manual inputs on the joystick from the operator and increasing the comfort.

Available on every Orsi Group Reach Mower.





***VERTICAL FLOAT**

Automatic floatation system of the cutting head on the ground, reduces the number of manual inputs and increases the comfort while working.

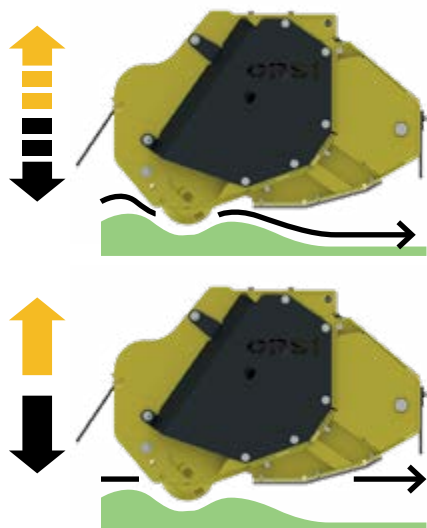

VERTICAL FLOAT

A hydropneumatic suspension which allows the cutting to follow the shape of the ground on a vertical plane.

It reduces significantly the need of manual actions to adjust the position.

- Reduction of manual inputs;
- Floatation range up to 35 cm ;
- Pressurized nitrogen accumulator;
- Constant cutting height;
- Reduction of a premature wear on tools and skids.



* Depending on machine and ground conditions

HARDOX AND STRENX



WHY WE USE HARDOX?

Hardox® 450

The most popular abrasion-resistant steel with excellent structural properties.

Hardox® 450 is an abrasion-resistant steel with a nominal hardness of 450 HBW. Hardox® 450 combines good bendability and weldability with an option for guaranteed impact toughness (Hardox® 450 Tuf).

The products can be used in many different components and structures that are subject to wear. Hardox® 450, with an extra 50 Brinell hardness over our 400 grade, provides better dent and abrasion resistance as well as longer wear life, so you can achieve even greater savings.



WHY WE USE STRENX?

Superior properties

Strenx® steel has extremely consistent properties, ensuring precision and efficiency in the workshop.

If you think all steel is basically the same, Strenx® performance steel will change your thinking. Strong and reliable from surface to core, Strenx® steel features exceptional surface quality as well as impressive thickness and flatness tolerances verified by the Strenx® guarantees. The steel's properties - yield and tensile strength, bending performance, impact toughness - are carefully tested to ensure reliability and consistency in every delivery.

CUTTING HEADS

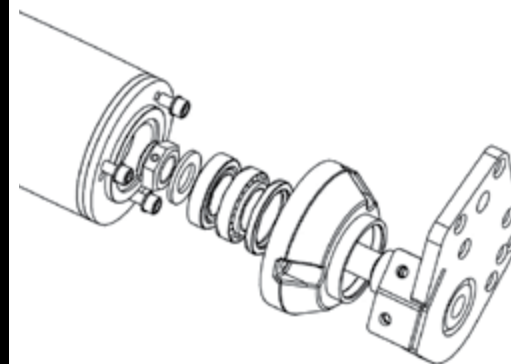

PROFESSIONAL REAR ROLLER Ø 140 mm (optional) with 4 taper roller bearings, mud scraper and interchangeable central body.

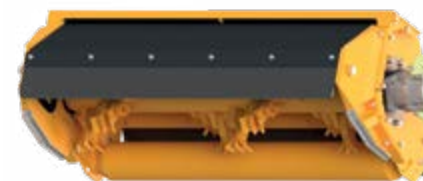

DIRECT TRANSMISSION
The hydraulic motor is installed directly on the side of the cutting head, protected by a robust carter.



BELTS TRANSMISSION
The hydraulic motor is installed internally; the power output is transmitted by belts and pulleys. The size is significantly reduced allowing to work in narrow spaces.



REAR ROLLER ADJUSTABLE IN HEIGHT

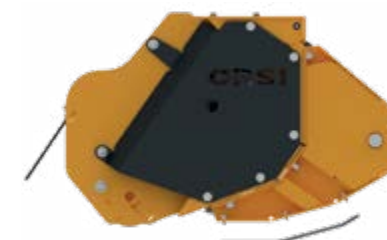

SKIDS (standard)
Standard equipment in all PROF cutting heads, substitutable in a few minutes.

CUTTING HEAD AGRI	DIRECT TRANSMISSION	BELTS TRANSMISSION
Double frame	✓	✓
Multi-knife rotor	✓	✓
Oscillating bearings with double rows of balls	✓	✓
Hardox counter knife	✓	✓
Cutting Head with floating and self-leveling system	✓	✓
Head rotation	✓	✓
Double rotation of the rotor	✓	✓
Skids	✓	✓
Professional rear roller Ø 140 mm (Ø 5,5") with 4 roller bearings, mud scraper and interchangeable central body	•	•
CUTTING HEAD GARDENING		
Oscillating bearings with double rows of balls	✓	-
Head rotation	✓	-
Double rotation of the rotor	✓	-
Side skids on head	•	•



CUTTING HEADS

ROTOR / TOOLS



PD REAR MOUNTED



PS MOUNTING ON TOP

TOOLS

A GRASS
max Ø 1,5 cm / 0,6"

D GRASS AND WOOD
max Ø 3 cm / 1,2"

N WOOD
max Ø 5 cm / 2"

S GRASS AND WOOD
max Ø 2,5 cm / 1"

E GRASS AND WOOD
max Ø 3 cm / 1,2"

O GRASS AND WOOD
max Ø 3 cm / 1,2"

F HEDGES
max Ø 4 cm / 1,6"

GARDENING

DIRECT TRANSMISSION



MULTI-KNIFE ROTOR

ROTOR

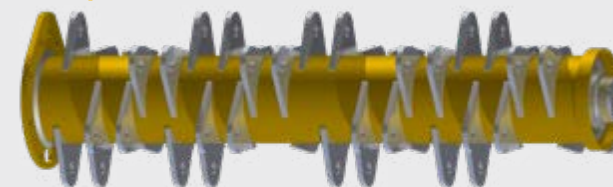

A  A: Ø 90 x 6 mm
A: Ø 3,6" x 0,3"

31" / 80 cm



A



S

 FOR MULTI-KNIFE ROTOR, SPECIFY THE CHOICE TOOL AT TIME OF ORDER

AGRI PS

DIRECT TRANSMISSION



AGRI PS

BELTS TRANSMISSION



AGRI PD

DIRECT TRANSMISSION



AGRI PD

BELTS TRANSMISSION



MULTI-KNIFE ROTOR

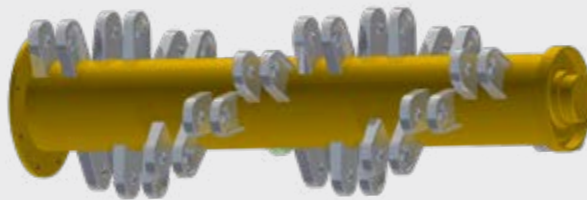

31" / 80 cm
41" / 105 cm
49" / 125 cm

A: \varnothing 102 x 12,5 mm
A: \varnothing 4" x 0,5"



CUT REVERS

029 | 030





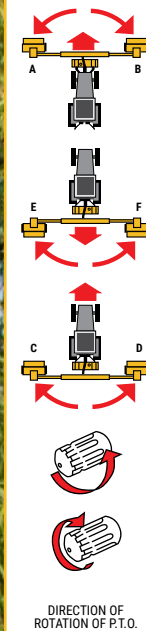



COMPASS

16 - 35 HP

VERSION AVAILABLE TO BE MOUNTED:
 REAR RIGHT | REAR LEFT
 FRONT RIGHT | FRONT LEFT
 REVERSE DRIVE RIGHT | REVERSE DRIVE LEFT





MODEL	 min	 hp/kw	 min	 min	 CAT.	 rpm / min	 rpm / min	 rpm / min
029	800 kg / 1763 lbs	16 HP/12 kW	100 cm / 39"	313 cm / 123"	I	540	1000*	3350
029 SX	800 kg / 1763 lbs	16 HP/12 kW	100 cm / 39"	313 cm / 123"	I	540	1000*	3350
030	800 kg / 1763 lbs	16 HP/12 kW	100 cm / 39"	315 cm / 124"	I	540	1000*	3350
030 SX	800 kg / 1763 lbs	16 HP/12 kW	100 cm / 39"	315 cm / 124"	I	540	1000*	3350

* with frontal hitch

CUT REVERS	029 / 029 SX	030 / 030 SX
HYDRAULIC SYSTEM		
Oil tank capacity	65 lt	65 lt
Arm movements oil flow rate	7 lt/min a 170 bar	7 lt/min a 170 bar
Cutting head oil flow rate	40 lt/min a 210 bar	40 lt/min a 210 bar
Hp / kW head rotor	25 hp / 18,6 kW	25 hp / 18,6 kW
4 kW oil-cooler with thermostat	•	•
TRANSMISSION		
Hydraulic motor	Alloy Gr. 2	Alloy Gr. 2
Hydraulic pumps	Alloy	Alloy
Multiplier	Alloy	Alloy
SAFETY		
Safety spring on 2nd arm	✓	✓
HITCH		
Stabilizers	✓	✓
Bracket	•	•
Frontal mounted supplement price - PTO 1000 rpm	•	•
CONTROLS		
Classic	✓	✓
Easy-tronic	•	•

DIRECT TRANSMISSION

WORKING WIDTH

CUTTING HEAD	80	80
		
GARDENING SERIES		
MODELS		
029 / 029 SX	✓	•
030 / 030 SX	✓	•

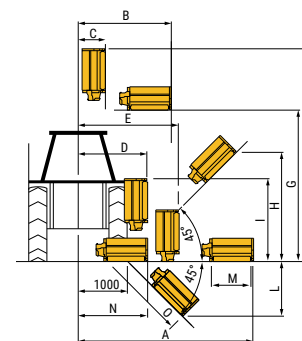

cm / inch	029 / 029 SX	030 / 030 SX
A	313 cm / 123"	315 cm / 124"
B	153 cm / 60"	158 cm / 62"
C	50 cm / 20"	50 cm / 20"
D	61 cm / 24"	62 cm / 24,4"
E	167 cm / 66"	158 cm / 62"
F	376 cm / 148"	386 cm / 152"
G	243 cm / 96"	232 cm / 91"
H	196 cm / 77"	198 cm / 78"
I	150 cm / 59"	151 cm / 59,5"
L	113 cm / 44"	119 cm / 47"
M	80 cm / 31"	80 cm / 31"
N	134 cm / 53"	134 cm / 53"
O	160 cm / 63"	168 cm / 66"









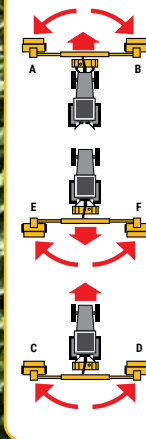

HEDGE

160

COMPASS

20 - 70 HP



MODEL	  	 hp/kW	 mm	 mm	 kg	CAT.
160	800 kg / 1763 lbs	16 HP/12 kW	100 cm / 39"	423 cm / 166"	190 kg / 419 lbs	I-II

HEDGE	160
HYDRAULIC SYSTEM	
Minimum oil flow	15-20 lt
Oil flow rate pruning bar head 100 cm/39" max Ø cutting 1 cm/0,39"	see motor list below
Oil flow rate pruning bar head 160 cm/63" max Ø cutting 1 cm/0,39"	see motor list below
Priority compensated flow control in the hydraulic system, excess to pressure	✓
CONTROLS	
Classic (tele flexible control with floating)	✓
Quick couplings tractors	✓
Classic (tele flexible control with floating) Cable L=2000	•
Classic (tele flexible control with floating) Cable L=3000	•

(A.) PRUNING CUTTING



(B.) HEDGE BAR



AT WISH WHEN ORDERING

CYL. C.C.	FLOW RATE	BAR PRESSURE
32 c.c.	7 l/min	90
40 c.c.	8 l/min	70
50 c.c.	10 l/min	60

AT WISH WHEN ORDERING

CYL. C.C.	FLOW RATE	BAR PRESSURE
50 c.c.	15 l/min	120
80 c.c.	17 l/min	120
100 c.c.	20 l/min	120
125 c.c.	25 l/min	120
160 c.c.	40 l/min	120

Max. cutting Ø only guaranteed by motor with highest cc.

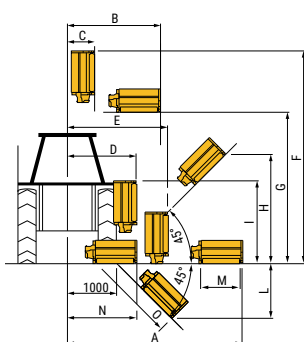

cm / inch	160
A	423 cm / 166"
B	225 cm / 88"
C	105 cm / 41"
D	64 cm / 25"
E	290 cm / 114"
F	505 cm / 199"
G	340 cm / 134"
H	284 cm / 112"
I	216 cm / 85"
L	113 cm / 44"
M	160 cm / 63"
N	212 cm / 83"
O	163 cm / 64"

✓ STANDARD EQUIPMENT | • OPTIONAL EQUIPMENT | - NOT AVAILABLE



WORKING WIDTH

RIVER COMPACT

355 | 420

COMPASS

25 - 55 HP

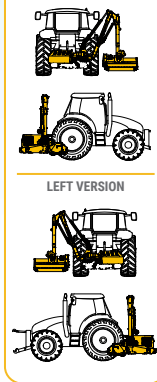

LEFT VERSION



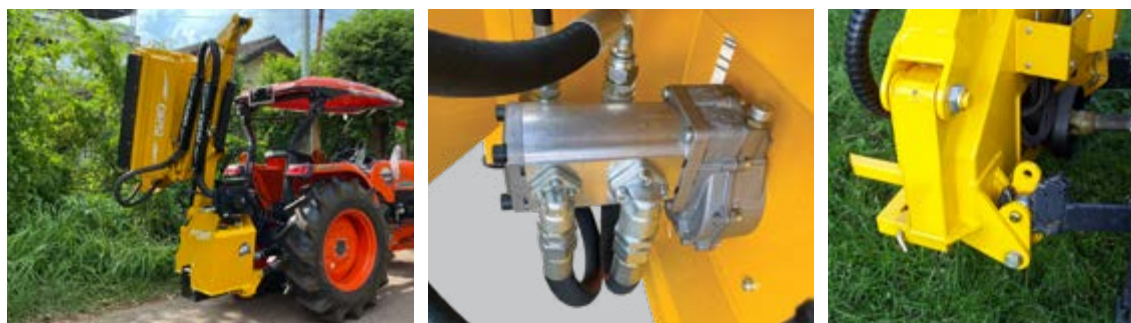

MODEL	 	 hp/kW					CAT.		rpm / min
355 / 355 sx	1500 kg / 3307 lbs	25 HP / 18,6 kW	150 cm / 331"	345 cm / 760"	515 kg / 1135 lbs	I	540	2800	
420 / 420 sx	1800 kg / 3968 lbs	35 HP / 26 kW	160 cm / 63"	425 cm / 937"	595 kg / 1312 lbs	I	540	2800	

RIVER COMPACT	355 / 355 SX	420 / 420 SX
MACHINE		
Recommended use / till - hours/year	250	250
2° Arm ending and joint group in cast iron	✓	✓
HYDRAULIC SYSTEM		
Oil tank capacity	75 lt	75 lt
Arm movements oil flow rate	10 lt/min a 180 bar	10 lt/min a 180 bar
Cutting head oil flow rate	56 lt/min a 180 bar	56 lt/min a 180 bar
Hp / kW head rotor	40 hp / 29,8 kW	40 hp / 29,8 kW
7 kW oil-cooler with thermostat	•	•
Manual hydropneumatic head suspension	•	•
Electric vertical floating on the first arm (suspension by a nitrogen accumulator) <i>(only with easy-tronic command)</i>	•	•
TRANSMISSION		
Hydraulic motor	Alloy Gr. 2	Alloy Gr. 2
Hydraulic pumps	Alloy	Alloy
Multiplier	Alloy	Alloy
Cardan shaft 3x900	✓	✓
SAFETY		
Mechanical safety system	✓	✓
HITCH		
Stabilizers	✓	✓
Bracket	•	•
CONTROLS		
Classic	✓	✓
Easy-tronic	•	•



✓ STANDARD EQUIPMENT | • OPTIONAL EQUIPMENT | - NOT AVAILABLE

DIRECT TRANSMISSION

CUTTING HEAD	80	105
		
MODELS		
355 / 355 SX	✓	•
420 / 420 SX	✓	•

WORKING WIDTH

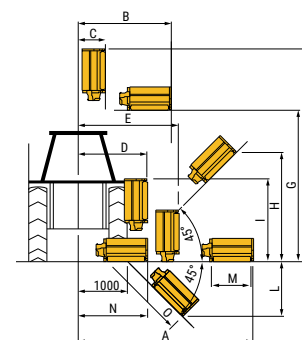

cm / inch	355 / 355 SX	420 / 420 SX
A	345 cm / 136"	425 cm / 167"
B	165 cm / 65"	220 cm / 87"
C	65 cm / 25"	100 cm / 39"
D	90 cm / 35"	120 cm / 47"
E	230 cm / 90"	275 cm / 108"
F	440 cm / 173"	525 cm / 207"
G	300 cm / 118"	370 cm / 146"
H	245 cm / 96"	315 cm / 124"
I	200 cm / 79"	230 cm / 90"
L	135 cm / 53"	195 cm / 76"
M	80 cm / 31"	105 cm / 41"
N	140 cm / 55"	155 cm / 61"
O	190 cm / 74"	270 cm / 106"









RIVER COMPACT PLUS

450 | 500 | 580

COMPASS

50 - 90 HP



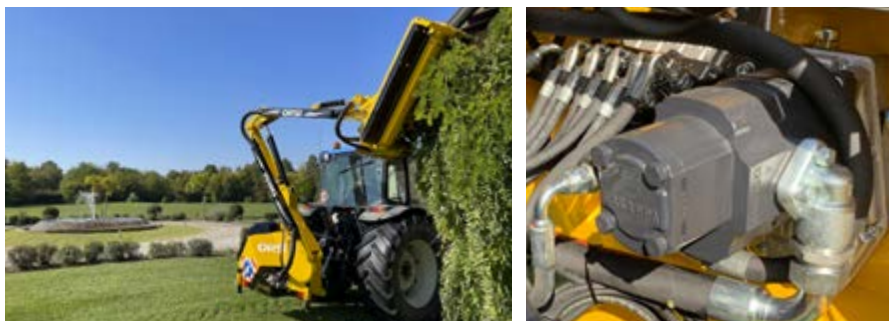

MODEL	  	 hp/kW					CAT.		rpm / min
450	1800 kg / 3968 lbs	45 HP / 33,5 kW	160 cm / 63"	446 cm / 175"	750 kg / 1653 lbs	I-II	540	3110	
500	2000 kg / 4409 lbs	45 HP / 33,5 kW	160 cm / 63"	492 cm / 194"	785 kg / 1730 lbs	I-II	540	3110	
580	2200 kg / 4850 lbs	45 HP / 33,5 kW	180 cm / 71"	580 cm / 228"	835 kg / 1841 lbs	I-II	540	3110	

RIVER COMPACT PLUS	450	500	580
MACHINE			
Recommended use / till - hours/year	400	400	400
2° Arm ending and joint group in cast iron	✓	✓	✓
Bumper with lights	•	•	•
HYDRAULIC SYSTEM			
Oil tank capacity	155 lt	155 lt	155 lt
Arm movements oil flow rate	26 lt/min a 180 bar	26 lt/min a 180 bar	26 lt/min a 180 bar
Cutting head oil flow rate	84 lt/min a 180 bar	84 lt/min a 180 bar	84 lt/min a 180 bar
Hp / kW head rotor	50 hp / 37,5 kW	50 hp / 37,5 kW	50 hp / 37,5 kW
7 kW oil-cooler with thermostat	•	•	•
Manual hydropneumatic head suspension	•	•	•
Electric vertical floating on the first arm (suspension by a nitrogen accumulator) (only with easy-tronic and smart-tronic command)	•	•	•
TRANSMISSION			
Hydraulic motor	Cast Iron Gr. 3	Cast Iron Gr. 3	Cast Iron Gr. 3
Hydraulic pumps	Alloy/Cast Iron	Alloy/Cast Iron	Alloy/Cast Iron
Multiplier	Alloy	Alloy	Alloy
Cardan shaft 5x1000	✓	✓	✓
SAFETY			
Mechanical safety system	✓	✓	✓
HITCH			
Stabilizers	✓	✓	✓
Bracket (NOT with stabilizers hitch plate)	•	•	•
Stabilizers hitch plate	•	•	•
CONTROLS			
Classic	✓	✓	✓
Easy-tronic	•	•	•
Smart-tronic out of production from the 31/12/2022	•	•	•
NEW Smart-tronic V2.1 available starting from the 1/1/2023	•	•	•





✓ STANDARD EQUIPMENT | • OPTIONAL EQUIPMENT | - NOT AVAILABLE

DIRECT TRANSMISSION

CUTTING HEAD	80	105	125
			
MODELS			
450	•	✓	•
500	•	✓	•
580	•	✓	•

BELTS TRANSMISSION

CUTTING HEAD	105	125
		
MODELS		
450	•	•
500	•	•
580	•	•

WORKING WIDTH

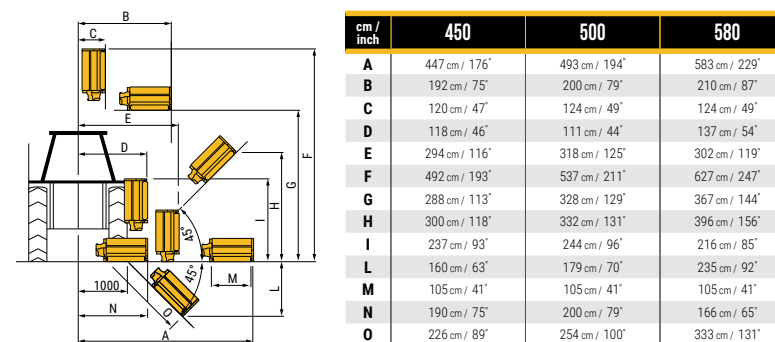

RIO







450 | 500 | 580

COMPASS



45 - 90 HP



MODEL		 hp/kW				 CAT.		rpm / min
450	1800 kg / 3968 lbs	45 HP / 33,5 kW	160 cm / 63"	446 cm / 175"	750 kg / 1653 lbs	I-II	540	3110
500	2000 kg / 4409 lbs	45 HP / 33,5 kW	160 cm / 63"	492 cm / 194"	785 kg / 1730 lbs	I-II	540	3110
580	2200 kg / 4850 lbs	45 HP / 33,5 kW	180 cm / 71"	580 cm / 228"	835 kg / 1841 lbs	I-II	540	3110

RIO	450	500	580
MACHINE			
Recommended use / till - hours/year	400	400	400
Cast iron frame (A.)	✓	✓	✓
2° Arm ending and joint group in cast iron (B.)	✓	✓	✓
Bumper with lights	•	•	•
HYDRAULIC SYSTEM			
Oil tank capacity	155 lt	155 lt	155 lt
Arm movements oil flow rate	26 lt/min a 180 bar	26 lt/min a 180 bar	26 lt/min a 180 bar
Cutting head oil flow rate	84 lt/min a 180 bar	84 lt/min a 180 bar	84 lt/min a 180 bar
Hp / kW head rotor	50 hp / 37,5 kW	50 hp / 37,5 kW	50 hp / 37,5 kW
10 kW oil-cooler with thermostat	•	•	•
Manual hydropneumatic head suspension	•	•	•
Electric vertical floating on the first arm (suspension by a nitrogen accumulator) (only with smart-tronic and easy-tronic command)	•	•	•
TRANSMISSION			
Hydraulic motor	Cast Iron Gr. 3	Cast Iron Gr. 3	Cast Iron Gr. 3
Hydraulic pumps	Cast Iron	Cast Iron	Cast Iron
Multiplier	Alloy	Alloy	Alloy
Cardan shaft 5x1000	✓	✓	✓
SAFETY			
Safety device with mechanical shock absorber on the 2nd arm (C.)	✓	✓	✓
HITCH			
Stabilizers	✓	✓	✓
Bracket <i>(NOT with stabilizers hitch plate)</i>	•	•	•
Stabilizers hitch plate	•	•	•
CONTROLS			
Classic	✓	✓	✓
Easy-tronic	•	•	•
Smart-tronic out of production from the 31/12/2022	•	•	•
NEW Smart-tronic V2.1 available starting from the 1/1/2023	•	•	•



(A.)





(B.)





(C.)

✓ STANDARD EQUIPMENT | • OPTIONAL EQUIPMENT | - NOT AVAILABLE

DIRECT TRANSMISSION

CUTTING HEAD	80	105	125
			
MODELS			
450	•	✓	•
500	•	✓	•
580	•	✓	•

BELTS TRANSMISSION

CUTTING HEAD	105	125
		
MODELS		
450	•	•
500	•	•
580	•	•

WORKING WIDTH

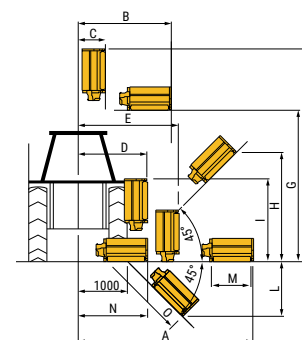

cm / inch	450	500	580
A	446 cm / 175"	492 cm / 194"	580 cm / 228"
B	255 cm / 100"	272 cm / 107"	321 cm / 126"
C	114 cm / 44,8"	114 cm / 44,8"	115 cm / 45"
D	118 cm / 46"	109 cm / 43"	138 cm / 54"
E	269 cm / 106"	291 cm / 114"	252 cm / 99"
F	452 cm / 178"	498 cm / 196"	586 cm / 231"
G	267 cm / 105"	308 cm / 121"	361 cm / 142"
H	284 cm / 112"	316 cm / 124"	378 cm / 149"
I	196 cm / 77"	205 cm / 81"	181 cm / 71"
L	205 cm / 81"	231 cm / 91"	283 cm / 111"
M	105 cm / 41"	105 cm / 41"	105 cm / 41"
N	192 cm / 75"	200 cm / 79"	186 cm / 73"
O	292 cm / 115"	328 cm / 129"	401 cm / 158"











PERFORMANCE

455 | 535

COMPASS

45 - 100 HP





MODEL	 	 hp/kW	 	 		 CAT.		rpm / min
450	1900 kg / 4188 lbs	45 HP / 33,5 kW	170 cm / 67"	455 cm / 179"	820 kg / 1808 lbs	II	540	3110
535	2100 kg / 4629 lbs	45 HP / 33,5 kW	180 cm / 71"	530 cm / 201"	865 kg / 1907 lbs	II	540	3110

PERFORMANCE	455	535
MACHINE		
Recommended use / till - hours/year	400	400
2° Arm ending and joint group in cast iron	✓	✓
Led lights	•	•
HYDRAULIC SYSTEM		
Oil tank capacity	140 lt	140 lt
Arm movements oil flow rate	15 lt/min a 180 bar	15 lt/min a 180 bar
Cutting head oil flow rate	84 lt/min a 180 bar	84 lt/min a 180 bar
Hp / kW head rotor	50 hp / 37,5 kW	50 hp / 37,5 kW
10 kW oil cooler with auto-reverse fan with automatic variable speed and integrated by-pass valve	•	•
Manual hydropneumatic head suspension	•	•
Electric vertical floating on the first arm (suspension by a nitrogen accumulator) (only with smart-tronic and easy-tronic command)	•	•
TRANSMISSION		
Hydraulic motor	Cast Iron Gr. 3	Cast Iron Gr. 3
Hydraulic pumps	Cast Iron Gr. 3	Cast Iron Gr. 3
Multiplier	Alloy	Alloy
Cardan shaft 5x1000	✓	✓
SAFETY		
105° hydraulic rotation with safety valve	✓	✓
HITCH		
Stabilizers	✓	✓
Bracket <i>(NOT with stabilizers hitch plate)</i>	•	•
Stabilizers hitch plate	•	•
CONTROLS		
Classic	✓	✓
Easy-tronic	•	•
Smart-tronic out of production from the 31/12/2022	•	•
NEW Smart-tronic V2.1 available starting from the 1/1/2023	•	•





✓ STANDARD EQUIPMENT | • OPTIONAL EQUIPMENT | - NOT AVAILABLE

DIRECT TRANSMISSION

CUTTING HEAD	80	105	125
	 D E F N O		
MODELS			
455	•	✓	•
535	•	✓	•

BELTS TRANSMISSION

CUTTING HEAD	105	125
	 D E F N O	
MODELS		
455	•	•
535	•	•

WORKING WIDTH

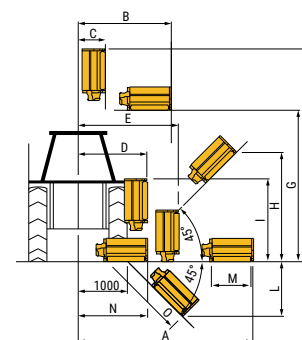

cm / inch	455	535
A	455 cm / 179"	535 cm / 201"
B	217 cm / 85"	226 cm / 89"
C	67 cm / 26"	80 cm / 31"
D	153 cm / 60"	106 cm / 42"
E	229 cm / 90"	233 cm / 91"
F	547 cm / 215"	642 cm / 253"
G	409 cm / 161"	475 cm / 187"
H	296 cm / 116"	385 cm / 151"
I	197 cm / 77"	185 cm / 72"
L	185 cm / 73"	262 cm / 103"
M	125 cm / 49"	105 cm / 41"
N	195 cm / 77"	190 cm / 75"
O	266 cm / 105"	370 cm / 146"

PERFORMANCE PARALLELOGRAM

510

PARALLELOGRAM

45 - 100 HP





MODEL	min	hp/kW	mm	mm	kg/lbs	CAT.	rpm / min
510	2300 kg / 5070 lbs	45 HP/33,5 kW	170 cm / 67"	510 cm / 201"	865 kg / 1907 lbs	II	540 3110

PERFORMANCE PARALLELOGRAM	510
MACHINE	
Recommended use / till - hours/year	400
2° Arm ending and joint group in cast iron	✓
Led lights	•
HYDRAULIC SYSTEM	
Oil tank capacity	140 lt
Arm movements oil flow rate	15 lt/min a 180 bar
Cutting head oil flow rate	84 lt/min a 180 bar
Hp / kW head rotor	50 hp / 37,5 kW
10 kW oil cooler with auto-reverse fan with automatic variable speed and integrated by-pass valve	•
Manual hydropneumatic head suspension	•
Electric vertical floating on the first arm (suspension by a nitrogen accumulator) (only with smart-tronic and easy-tronic command)	•
TRANSMISSION	
Hydraulic motor	Cast Iron Gr. 3
Hydraulic pumps	Cast Iron Gr. 3
Multiplier	Alloy
Cardan shaft 5x1000	✓
SAFETY	
105° hydraulic rotation with safety valve	✓
HITCH	
Stabilizers	✓
Bracket <i>(NOT with stabilizers hitch plate)</i>	•
Stabilizers hitch plate	•
CONTROLS	
Classic	✓
Easy-tronic	•
Smart-tronic out of production from the 31/12/2022	•
NEW Smart-tronic V2.1 available starting from the 1/1/2023	•





✓ STANDARD EQUIPMENT | • OPTIONAL EQUIPMENT | - NOT AVAILABLE

DIRECT TRANSMISSION

CUTTING HEAD	80	105	125
			
MODELS			
510	•	✓	•

BELTS TRANSMISSION

CUTTING HEAD	105	125
		
MODELS		
535	•	•

WORKING WIDTH

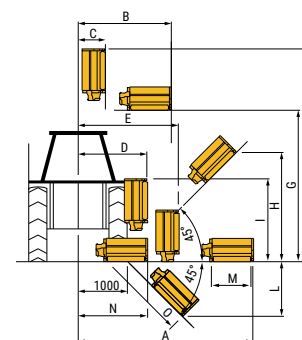

cm	510P
A	510 cm / 201"
B	260 cm / 102"
C	265 cm / 104"
D	148 cm / 58"
E	126 cm / 49"
F	565 cm / 222"
G	458 cm / 180"
H	340 cm / 134"
I	216 cm / 85"
L	220 cm / 87"
M	125 cm / 49"
N	195 cm / 77"
O	310 cm / 122"

PERFORMANCE

PARALLELOGRAM

VISUAL

510

**PARALLELOGRAM
SEMI-ADVANCED**



75 - 105 HP





MODEL	  	 hp/kw	 	 	 	 CAT.	 rpm / min
510	2300 kg / 5070 lbs	45 HP / 33,5 kW	170 cm / 67"	510 cm / 201"	865 kg / 1907 lbs	II	540

PERFORMANCE <i>PARALLELOGRAM VISUAL</i>	510
MACHINE	
Recommended use / till - hours/year	400
2° Arm ending and joint group in cast iron	✓
Led lights	•
HYDRAULIC SYSTEM	
Oil tank capacity	140 lt
Arm movements oil flow rate	15 lt/min a 180 bar
Cutting head oil flow rate	84 lt/min a 180 bar
Hp / kW head rotor	50 hp / 37,5 kW
10 kW oil cooler with auto-reverse fan with automatic variable speed and integrated by-pass valve	•
Manual hydropneumatic head suspension	•
Electric vertical floating on the first arm (suspension by a nitrogen accumulator) <i>(only with smart-tronic and easy-tronic command)</i>	•
TRANSMISSION	
Hydraulic motor	Cast Iron Gr. 3
Hydraulic pumps	Cast Iron Gr. 3
Multiplier	Alloy
Cardan shaft 5x1000	✓
SAFETY	
105° hydraulic rotation with safety valve	✓
HITCH	
Stabilizers	✓
Bracket <i>(NOT with stabilizers hitch plate)</i>	•
Stabilizers hitch plate	•
CONTROLS	
Classic	✓
Easy-tronic	•
Smart-tronic out of production from the 31/12/2022	•
NEW Smart-tronic V2.1 available starting from the 1/1/2023	•





✓ STANDARD EQUIPMENT | • OPTIONAL EQUIPMENT | - NOT AVAILABLE

DIRECT TRANSMISSION

CUTTING HEAD	80	105	125
			
MODELS			
510	•	✓	•

BELTS TRANSMISSION

CUTTING HEAD	105	125
		
MODELS		
535	•	•

WORKING WIDTH

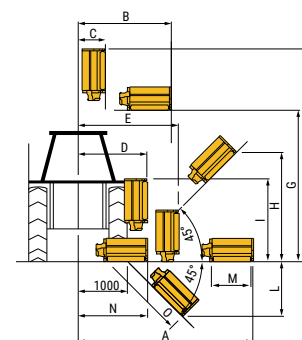

cm	510P
A	510 cm / 201"
B	260 cm / 102"
C	265 cm / 104"
D	148 cm / 58"
E	126 cm / 49"
F	565 cm / 222"
G	458 cm / 180"
H	340 cm / 134"
I	216 cm / 85"
L	220 cm / 87"
M	125 cm / 49"
N	195 cm / 77"
O	310 cm / 122"

VIGNA TELESCOPIC

615

COMPASS

80 - 120 HP

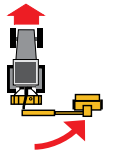



MODEL	m	hp/kW	m	m	kg	CAT.	rpm / min
615	2200 kg / 4850 lbs	45 HP / 33,5 kW	170 cm / 67"	615 cm / 242"	820 kg / 1808 lbs	II	540 3110

VIGNA TELESCOPIC		615
MACHINE		
Recommended use / till - hours/year		400
2° Arm ending and joint group in cast iron		✓
HYDRAULIC SYSTEM		
Oil tank capacity		155 lt
Arm movements oil flow rate		15 lt/min a 180 bar
Cutting head oil flow rate		84 lt/min a 180 bar
Hp / kW head rotor		50 HP / 37,5kW
7 kW oil-cooler with thermostat		•
Manual hydropneumatic head suspension		•
Electric vertical floating on the first arm (suspension by a nitrogen accumulator) <i>(only with Easy-tronic command)</i>		•
TRANSMISSION		
Hydraulic motor		Cast iron Gr. 3
Hydraulic pumps		Alloy Gr. 3
Multiplier		Alloy
Cardan shaft 5x700		✓
SAFETY		
105° hydraulic rotation with safety valve		✓
HITCH		
Stabilizers		✓
Bracket (NOT with stabilizers hitch plate)		•
Stabilizers hitch plate		•
CONTROLS		
Classic		✓
Easy-tronic		•





✓ STANDARD EQUIPMENT | • OPTIONAL EQUIPMENT | - NOT AVAILABLE

DIRECT TRANSMISSION

CUTTING HEAD	80	105	125
			
MODELS			
615	•	✓	•

BELTS TRANSMISSION

CUTTING HEAD	105	125
		
MODELS		
615	•	•

WORKING WIDTH

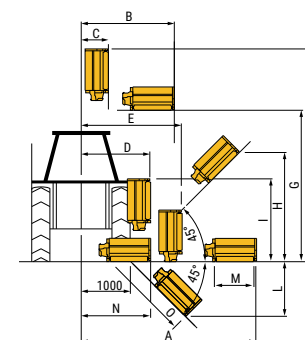

cm	615
A	615 cm / 242"
B	495 cm / 195"
C	280 cm / 110"
D	230 cm / 90"
E	150 cm / 103"
F	540 cm / 212"
G	295 cm / 116"
H	460 cm / 181"
I	230 cm / 90"
L	275 cm / 108"
M	105 cm / 41"
N	210 cm / 83"
O	390 cm / 153"

LEADER







505 | 655 | 705-T

COMPASS



85 - 125 HP





MODEL			hp/kW					CAT.		rpm / min
505	2500 kg / 5511 lbs	50HP/37,5 kW	200 cm / 79"	508 cm / 200"	1100 kg / 2425 lbs	II	540	3110		
655	3500 kg / 7716 lbs	50HP/37,5 kW	200 cm / 79"	602 cm / 237"	1170 kg / 2579 lbs	II	540	3110		
705-T	3800 kg / 8277 lbs	50HP/37,5 kW	200 cm / 79"	690 cm / 272"	1270 kg / 2800 lbs	II	540	3110		



LEADER	505	655	705-T
MACHINE			
Recommended use / till - hours/year	700	700	700
Cast iron main frame and column (A.)	✓	✓	✓
Arms in Strenx 700	-	-	✓
Main joint in cast iron	✓	✓	✓
Bumper with lights a led	✓	✓	✓
HYDRAULIC SYSTEM			
Oil tank capacity	155 lt	155 lt	155 lt
Arm movements oil flow rate	25 lt/min a 180 bar	25 lt/min a 180 bar	25 lt/min a 180 bar
Cutting head oil flow rate	85 lt/min a 200 bar	85 lt/min a 200 bar	85 lt/min a 200 bar
Hp / kW head rotor	50 HP / 37,5 kW	50 HP / 37,5 kW	50 HP / 37,5 kW
10 kW oil cooler with auto-reverse fan with automatic variable speed and integrated by-pass valve	✓	✓	✓
Manual hydropneumatic head suspension			
Electric vertical floating on the first arm (suspension by a nitrogen accumulator) (only with Easy-tronic and Smart-tronic command)	•	•	•
TRANSMISSION			
Hydraulic motor	Cast iron Gr. 3	Cast iron Gr. 3	Cast iron Gr. 3
Hydraulic pumps	Cast iron Gr. 3	Cast iron Gr. 3	Cast iron Gr. 3
Multiplier	Alloy	Alloy	Alloy
Cardan shaft 5x700	✓	✓	✓
SAFETY			
105° hydraulic rotation with safety valve (B.)	✓	✓	✓
HITCH			
Stabilizers	✓	✓	✓
Bracket (NOT with stabilizers hitch plate)	•	•	•
Stabilizers hitch plate	•	•	•
Fix mounted frame RAPID LINK	•	•	•
CONTROLS			
Classic	✓	✓	✓
Easy-tronic	•	•	•
Smart-tronic out of production from the 31/12/2022	•	•	•
NEW Smart-tronic V2.1 available starting from the 1/1/2023	•	•	•



DIRECT TRANSMISSION

CUTTING HEAD	80	105	125
			
MODELS			
505	•	✓	•
655	•	✓	•
705-T	•	✓	•

BELTS TRANSMISSION

CUTTING HEAD	105	125
		
MODELS		
505	•	•
655	•	•
705-T	•	•

WORKING WIDTH

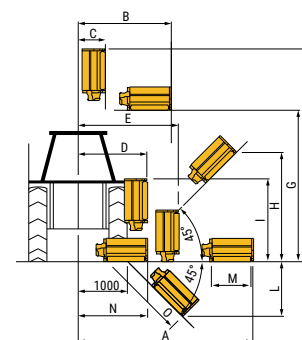

cm / inch	505	505	705-T
A	508 cm / 200"	602 cm / 237"	682 cm / 268"
B	192 cm / 76"	210 cm / 83"	271 cm / 107"
C	152 cm / 60"	148 cm / 58"	119 cm / 47"
D	140 cm / 55"	144 cm / 57"	165 cm / 65"
E	150 cm / 59"	150 cm / 59"	170 cm / 67"
F	492 cm / 194"	586 cm / 231"	724 cm / 285"
G	376 cm / 148"	454 cm / 179"	382 cm / 150"
H	324 cm / 128"	391 cm / 154"	475 cm / 187"
I	150 cm / 103"	163 cm / 64"	226 cm / 89"
L	262 cm / 55"	275 cm / 108"	388 cm / 153"
M	105 cm / 41"	125 cm / 49"	125 cm / 49"
N	212 cm / 84"	227 cm / 89"	244 cm / 96"
O	370 cm / 146"	390 cm / 154"	551 cm / 217"

DITCH CLEANER

ON ALL MODELS

Ditch cutter, ideal for the maintenance and cleaning of ditches, also perfect for mud-removal.



MODEL	max Ø	
Ø 50 cm	50 cm / 20"	130 kg / 186 lbs
Ø 65 cm	65 cm / 26"	190 kg / 418 lbs
Ø 80 cm	80 cm / 32"	230 kg / 507 lbs



 FLOW DIVIDER SUGGESTED ON HYDRAULIC SYSTEMS WITH FLOW RATE:
 > 90 lt/min Ø 50 cm (20") / Ø 65 cm (25")
 > 120 lt/min Ø 80 cm (31")

BRANCH CUTTER

ON ALL MODELS

A high-performance branch-cutter, fully built in HARDOX®. Ideal if you want to prune trees, hedges, bushes etc., in particular for those with a high trunk. Up to 10 cm / 4" of cutting Ø.



MODEL	max Ø 	←→	
155 HARDOX	10 cm / 4"	155 cm / 61"	200 kg / 441 lbs
225 HARDOX	10 cm / 4"	225 cm / 87"	230 kg / 507 lbs

NO on machines with piston system



 FLOW DIVIDER SUGGESTED ON HYDRAULIC SYSTEMS WITH FLOW RATE:
 > 60 lt/min

HEDGE BAR

ON ALL MODELS

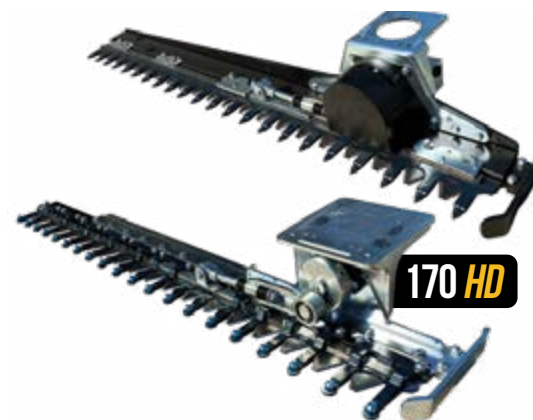
deal to prune or trim hedges and bushes. Equipped with strong blades for a fine and precise cut result. It can cut up to 5 cm / 2".



MODEL	max Ø 	←→	
125 cm	3 cm / 1,2"	125 cm / 49"	46 kg / 101 lbs
166 cm	3 cm / 1,2"	166 cm / 65"	58 kg / 128 lbs
200 cm	3 cm / 1,2"	200 cm / 79"	68 kg / 150 lbs
HD 170 cm	5 cm / 2"	170 cm / 67"	68 kg / 150 lbs



 FLOW DIVIDER SUGGESTED ON HYDRAULIC SYSTEMS WITH FLOW RATE:
 > 40 lt/min

DISC CUTTING BAR

ON ALL MODELS

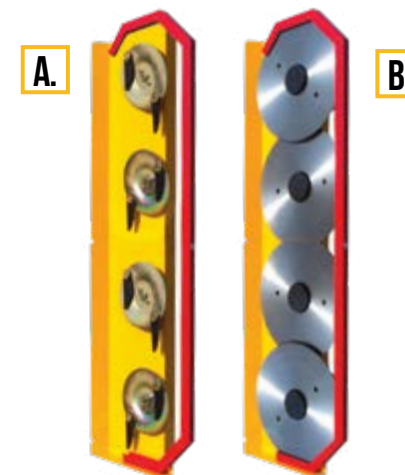
Rotary hedge cutter with discs or blades. Ideal to regularly prune little green areas. Light and practical.



MODEL	max Ø 	←→	
A. 165	2 cm / 0,8"	165 cm / 65"	150 kg / 331 lbs
B. 165 optional	4 cm / 1,6"	165 cm / 65"	150 kg / 331 lbs

NO on machines with piston system

 FLOW DIVIDER SUGGESTED ON HYDRAULIC SYSTEMS WITH FLOW RATE:
 > 40 lt/min



 The boom mower MUST BE EQUIPPED WITH AN ATTACHEMENT in order to be supplied (cutting head or any other attachment among the ones offered for the gamma).

TOPPER PFC 105

NO HEDGE / CUT REVERS / VIGNA TELESCOPIC

Rotary head with rotating blades, for cutting grass, shrubs, hedges and vegetation with diameters up to 5 cm/2". Designed for an excellent fine cut. This not only ensures a fine finish, but also retains most of the debris within the hedge for healthy growth and a tidy finish when used in this kind of job. Features and benefits: extremely durable, hydraulic front hood equally adept at cutting grass and hedges.



MODEL	max Ø	↔	
105	5 cm / 2"	105 cm / 41"	140÷150 kg 309÷331 lbs

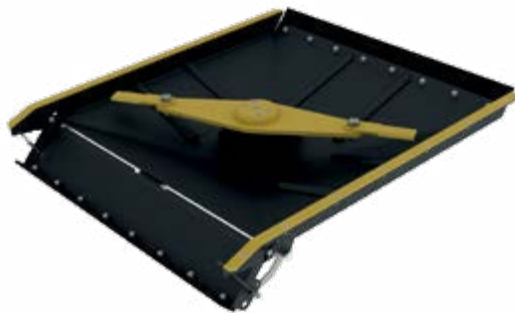

SNOW BLOWER

MODEL ONLY LEADER

Snow clearing machine, ideal for removing large quantities of snow, in conditions of high snowfall.



MODEL	↔	
100 cm	100 cm / 40"	270 / 310 kg 595 / 683 lbs



* Rotary Heads are not compatible with telescopic arm machines.



« The first Orsi Mulcher was purchased by my family about 25 years ago. The main quality we were looking for was reliability and performance of the machines in very difficult field conditions. The ORSI machines we have had are as reliable as possible, and have always done the work in the fields very well and importantly, we are extremely happy with the service. »

Azienda Agricola Boselli
Daniele e Filippo (BOLOGNA) Italia



ORSI GROUP S.R.L.

Via S. Andrea, 2A
Mascarino di Castello d'Argile
40050 / BOLOGNA / ITALY
Ph. +39 051 6867072
Fax +39 051 6867104

info@orsigroup.it
www.orsigroup.it